



GAMME PRISES D'EAU

- ▶ JUPE RÉHAUSSÉE
- ▶ FACILITE L'INSTALLATION

APPLIQUE
sortie : F1/2"



APPLIQUE & PIQUAGE
sortie : F1/2" + M3/8"

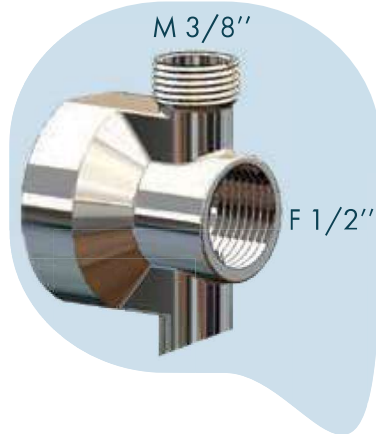

TÉ DE PIQUAGE
sortie : F1/2" + M3/8"

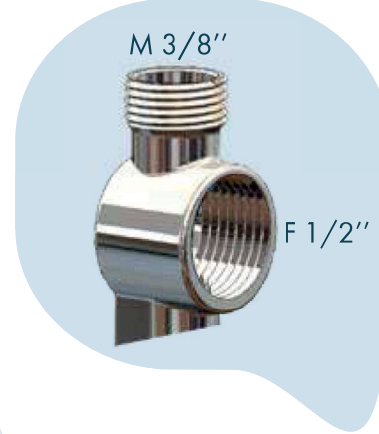

APPLIQUE
sortie : F1/2"

ARRIVÉE			Qté.	
À GLISSEMENT	12	1840S	1840K	1
	16	1841S	1841K	1
À SERTIR	12	1842S	1842K	1
	16	1843S	1843K	1
M1/2"	1844S	1844K	1	
F3/8' (éc.tournant)	1846S	1846K	1	

APPLIQUE & PIQUAGE
sortie : F1/2" + M3/8"

ARRIVÉE			Qté.	
À GLISSEMENT	12	1850S	1850K	1
	16	1851S	1851K	1
À SERTIR	12	1852S	1852K	1
	16	1853S	1853K	1
M1/2"	1854S	1854K	1	
F3/8' (éc.tournant)	1856S	1856K	1	

TÉ DE PIQUAGE
sortie : F1/2" + M3/8"

ARRIVÉE			Qté.
M1/2"	1858S	1858K	1
F3/8' (éc.tournant)	1859S	1859K	1

Sachet cavalier Sachet plastique



SANITAIRE & M.A.L.

SANITAIRE &
MACHINE À LAVER

SIMPLY'FIX : SUPPORTS D'INSTALLATION DE BAIGNOIRE

breveté



- ▶ CONFORMITÉ AU DT 03 - C
Acier galvanisé, matériau imputrescible
- ▶ RAPIDITÉ DE MONTAGE
Support déjà perforé, sécable et pliable

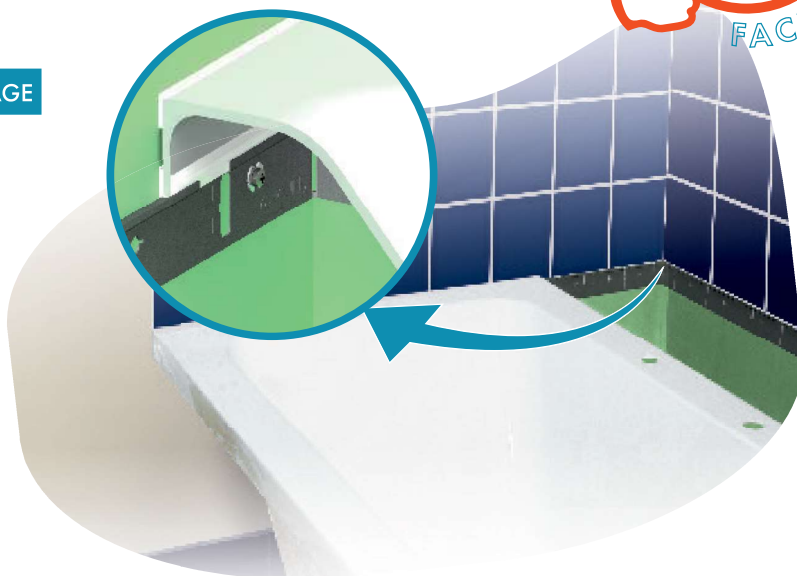

INSTALLATION



1 SIMPLY'FIX s'installe très aisément grâce aux adhésifs double face qui facilitent le positionnement.

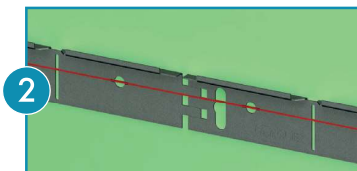

2 Les extrémités des supports sont conçues pour assurer la continuité du supportage.

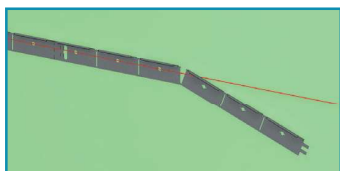

SIMPLY'FIX est sécable tous les 10 cm pour s'ajuster parfaitement à toutes les dimensions de baignoire.

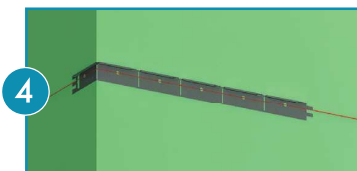

4 SIMPLY'FIX est pliable pour assurer la continuité de la tenue au niveau des angles du mur.



5 SIMPLY'FIX se fixe rapidement à l'aide de tous types de cheville grâce à ses perforations régulièrement espacées.



PACK	
4 supports de 60 cm + 12 chevilles pour plaque de plâtre	1820
colis de 60 supports sans chevilles	1822

Boîte Starfix

IDRO'CLIC : COLONNETTES DE BAIGNOIRE À RACCORDEMENT DIRECT

breveté



- ▶ **CONFORT**
Raccordement réalisé au-dessus de la baignoire
- ▶ **RAPIDITÉ & FIABILITÉ**
1 seul raccordement de la colonnette au tube (sans joint d'étanchéité)
- ▶ **QUALITÉ PRÉSERVÉE**
Pièces chromées montées en toute fin de travaux (évitant toute détérioration durant le chantier)
- ▶ **ACCESSIBILITÉ**
Raccordements visitables après pose sans trappe de visite. Garantie biennale.

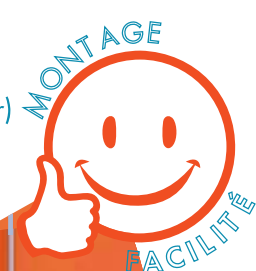

RACCORDEMENT	ARRIVÉE		
À GLISSEMENT	GL 12	1805	1805S
	GL 16	1801	1801S
À SERTIR	ST 12	1806	1806S
	ST 16	1802	1802S
MULTICOUCHE	16 x 2	1807	1807S



INSTALLATION

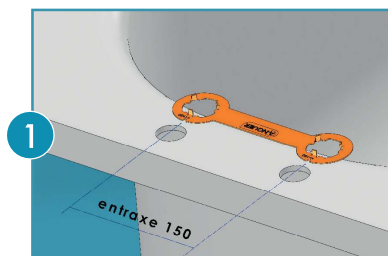

Utiliser le gabarit de pose fourni pour positionner l'emplacement des 2 trous d'entr'axe 150 mm. Percer 2 trous de Ø compris entre 30 et 35 mm.

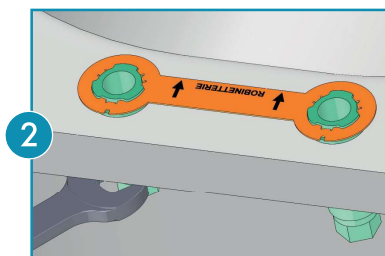

Glisser les embases de colonnettes dans les trous. Installer le gabarit de forme garantissant l'entr'axe 150 mm et permettant de régler l'alignement par rapport au rebord de la baignoire. Immobiliser les embases en serrant les écrous. Ôter le gabarit.

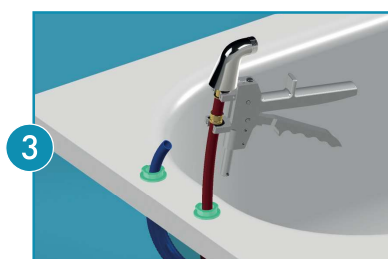
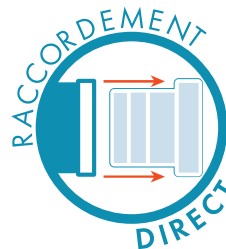

Sortir les tubes. Raccorder les colonnettes aux tubes selon le type de raccord choisi. (exemple d'un raccord à glissement sur tube PER).

Boîte Sachet cavalier



Engager chaque colonnette sur son embase en tenant compte des ergots.



Tourner les colonnettes (sorties vers la baignoire). Monter la robinetterie.

SANITAIRE & MACHINE À LAVER

SANITAIRE

UN CONDITIONNEMENT DE QUALITÉ



Cotes d'encombrement du produit

Désignation et dimensions

Référence de commande Anquier

Code-barres systématique pour une meilleure gestion de vos flux

Sur-emballage pour assurer la protection des pièces contre les chocs et rayures

ROBINETTERIE DE RÉNOVATION - MITIGEURS : 7 ENTR'AXES DISPONIBLES

Nos mitigeurs sont équipés d'un inverseur automatique blocable en position douche lorsque les pressions sont à minima.



M8
MITIGEUR DE DOUCHE
ARRIVÉE M1/2

ENTR'AXE (MM)	RÉF.	
60	M8 60	1
70	M8 70	1
80	M8 80	1
100	M8 100	1
110	M8 110	1
120	M8 120	1
135	M8 135	1



M9
MITIGEUR BAIN-DOUCHE
ARRIVÉE M1/2

ENTR'AXE (MM)	RÉF.	
60	M9 60	1
70	M9 70	1
80	M9 80	1
100	M9 100	1
110	M9 110	1
120	M9 120	1
135	M9 135	1





MD
MITIGEUR BAIN-DOUCHE AVEC SUPPORT DOUCHETTE - ARRIVÉE M1/2

ENTR'AXE (MM)	RÉF.	
60	MD 60	1
70	MD 70	1
80	MD 80	1
100	MD 100	1
110	MD 110	1
120	MD 120	1
135	MD 135	1

Boîte carton

SANITAIRE

ROBINETTERIE DE RÉNOVATION - MÉLANGEURS : 7 ENTR'AXES DISPONIBLES

A	B	C
S104	S104	S113
		
Tête à clapet - Croisillon : ABS	Tête à clapet - Croisillon : métal	Tête céramique 3/4 de tour Croisillon : métal

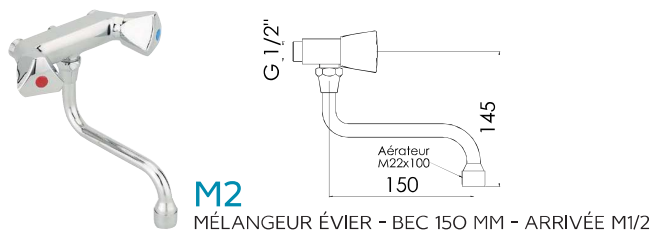

	ENTR'AXE (MM)	AVEC BRISE JET		AVEC AÉRATEUR		
		RÉF. AVEC BRISE JET	RÉF. AVEC AÉRATEUR	RÉF. AVEC BRISE JET	RÉF. AVEC AÉRATEUR	
A	60	M2 60 A	M2 60N A	M2 60N A	M2 60N A	1
	70	M2 70 A	M2 70N A	M2 70N A	M2 70N A	1
	80	M2 80 A	M2 80N A	M2 80N A	M2 80N A	1
	100	M2 100 A	M2 100N A	M2 100N A	M2 100N A	1
	110	M2 110 A	M2 110N A	M2 110N A	M2 110N A	1
B	60	M2 60 B	M2 60N B	M2 60N B	M2 60N B	1
	70	M2 70 B	M2 70N B	M2 70N B	M2 70N B	1
	80	M2 80 B	M2 80N B	M2 80N B	M2 80N B	1
	100	M2 100 B	M2 100N B	M2 100N B	M2 100N B	1
	110	M2 110 B	M2 110N B	M2 110N B	M2 110N B	1
C	60	M2 60 C	M2 60N C	M2 60N C	M2 60N C	1
	70	M2 70 C	M2 70N C	M2 70N C	M2 70N C	1
	80	M2 80 C	M2 80N C	M2 80N C	M2 80N C	1
	100	M2 100 C	M2 100N C	M2 100N C	M2 100N C	1
	110	M2 110 C	M2 110N C	M2 110N C	M2 110N C	1
	150	M2 150 C	M2 150N C	M2 150N C	M2 150N C	1



ENTR'AXE (MM)	A	B	C	
	RÉF.	RÉF.	RÉF.	
60	M2B 60 A	M2B 60 B	M2B 60 C	1
70	M2B 70 A	M2B 70 B	M2B 70 C	1
80	M2B 80 A	M2B 80 B	M2B 80 C	1
100	M2B 100 A	M2B 100 B	M2B 100 C	1
110	M2B 110 A	M2B 110 B	M2B 110 C	1
150	M2B 150 A	M2B 150 B	M2B 150 C	1



ENTR'AXE (MM)	A	B	C	
	RÉF.	RÉF.	RÉF.	
60	11B 60 A	11B 60 B	11B 60 C	1
70	11B 70 A	11B 70 B	11B 70 C	1
80	11B 80 A	11B 80 B	11B 80 C	1
100	11B 100 A	11B 100 B	11B 100 C	1
110	11B 110 A	11B 110 B	11B 110 C	1
150	11B 150 A	11B 150 B	11B 150 C	1



RÉF.	
R35B	1



ENTR'AXE (MM)	A	B	C	
	RÉF.	RÉF.	RÉF.	
110	110 A	110 B	110 C	1
150	150 A	150 B	150 C	1

SANITAIRE

ROBINETTERIE DE RÉNOVATION

A	B	C
S104	S104	S113
		
Tête à clapet - Croisillon : ABS	Tête à clapet - Croisillon : métal	Tête céramique 3/4 de tour Croisillon : métal



M3B
MONOTROU LAVABO

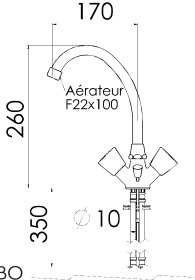

SANS VIDAGE - FLEXIBLES INOX + TIRETTE		
A	RÉF.	
A	M3B 2N A	1



M3
MONOTROU ÉVIER

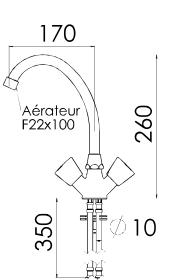

FLEXIBLES INOX		
A	RÉF.	
A	M3 34N A	1



M5B
MÉLANGEUR 2 TROUS
ÉCARTEMENT VARIABLE



A	RÉF.	
A	M5B O A	1



M6
MÉLANGEUR 3 TROUS
DESSOUS DE TABLE



A	RÉF.	
A	M6 A	1



M7
ROBINET PILIER

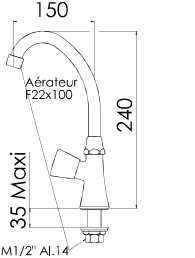

A	RÉF.	
A	M7 A	1



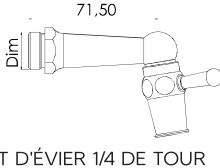

R1
ROBINET D'ÉVIER 1/4 DE TOUR



DIM.	RÉF.	
3/8	R1 38	1
1/2	R1 12	1

SANITAIRE

ROBINETTERIE DE RÉNOVATION

A	B	C
S104	S104	S113
		
Tête à clapet - Croisillon : ABS	Tête à clapet - Croisillon : métal	Tête céramique 3/4 de tour Croisillon : métal



R6
ROBINET D'ÉQUERRE
À TÊTE SIMPLE

DIM.	RÉF.	
1/2 - 1/2	R6 1212	1
1/2 - 3/4	R6 1234	1



R6B
ROBINET AUTO FORANT
TUBES Ø 10 À 16

RÉF.	
R6B	1



R5
ROBINET À BEC
ORIENTABLE

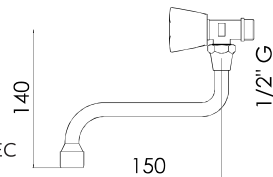

A	RÉF.	
A	R5 A	1



R8
ROBINET LAVABO

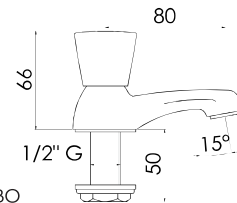

RÉF.	
R8 N A	1
R8 N B	1
R8 N C	1



R9
ROBINET BIDET

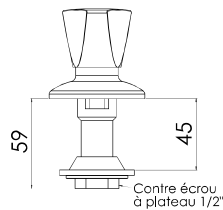

A	RÉF.	
A	R9 A	1



R29
PIED DE MÉLANGEUR
FIXATION PAR PATTE À VIS.

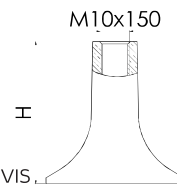

H	RÉF.	
48	R29 GM	1
38	R29 PM	1



R63
ROBINET À SIMPLE PÉDALE

DIM.	RÉF.	
Entrée 1/2 - sortie 1/2	R63 12	1



R64
ROBINET À DOUBLE PÉDALE

DIM.	RÉF.	
Entrée 1/2 - sortie 1/2	R64 12	1

SANITAIRE

TÊTES DE ROBINET



S105 C205
TÊTE UNIVERSELLE MONTÉE
AVEC CROISILLON ABS 3 PANS

DIM.	RÉF.		RÉF.	
3/8	S105 C205 38	2	S105 C205 38 K	1
1/2	S105 C205 12	2	S105 C205 12 K	1
16 x 150	S105 C205 16	2	S105 C205 16 K	1
17 x 150	S105 C205 17	2	S105 C205 17 K	1
18 x 150	S105 C205 18	2	S105 C205 18 K	1
19 x 150	S105 C205 19	2	S105 C205 19 K	1
20 x 150	S105 C205 20	2	S105 C205 20 K	1
21 x 150	S105 C205 21	2	S105 C205 21 K	1
22 x 150	S105 C205 22	2	S105 C205 22 K	1
23 x 150	S105 C205 23	2	S105 C205 23 K	1



S105 C209
TÊTE UNIVERSELLE MONTÉE
AVEC CROISILLON MÉTAL 3 PANS

DIM.	RÉF.		RÉF.	
3/8	S105 C209 38	2	S105 C209 38 K	1
1/2	S105 C209 12	2	S105 C209 12 K	1
16 x 150	S105 C209 16	2	S105 C209 16 K	1
17 x 150	S105 C209 17	2	S105 C209 17 K	1
18 x 150	S105 C209 18	2	S105 C209 18 K	1
19 x 150	S105 C209 19	2	S105 C209 19 K	1
20 x 150	S105 C209 20	2	S105 C209 20 K	1
21 x 150	S105 C209 21	2	S105 C209 21 K	1
22 x 150	S105 C209 22	2	S105 C209 22 K	1
23 x 150	S105 C209 23	2	S105 C209 23 K	1



C205
CROISILLON ABS
3 PANS CHROMÉ

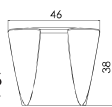

C209
CROISILLON MÉTAL
3 PANS CHROMÉ

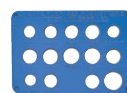
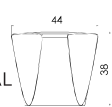

PLC
PLAQUE
DE CONTRÔLE

RÉF.		RÉF.	CDT.
C205	2	C205 K	1

RÉF.		RÉF.	
C209	2	C209 K	1

RÉF.	
PLC	1

Pas de 150 : Ø 17 à 23
Pas de 100 : Ø 18 à 22
Pas du gaz : 3/8 ; 1/2 ; 3/4



S105
TÊTE UNIVERSELLE CHROMÉE

DIM.	RÉF.		RÉF.	
3/8	S105 38	10	S105 38 K	1
1/2	S105 12	10	S105 12 K	1
16 x 150	S105 16	10	S105 16 K	1
17 x 150	S105 17	10	S105 17 K	1
18 x 150	S105 18	10	S105 18 K	1
19 x 150	S105 19	10	S105 19 K	1
20 x 150	S105 20	10	S105 20 K	1
21 x 150	S105 21	10	S105 21 K	1
22 x 150	S105 22	10	S105 22 K	1
23 x 150	S105 23	10	S105 23 K	1



S104
TÊTE CLAPET GUIDE

DIM.	RÉF.		RÉF.	
3/8	S104 38	10	S104 38 K	1
1/2	S104 12	10	S104 12 K	1
18 x 150	S104 18	10	S104 18 K	1
19 x 150	S104 19	10	S104 19 K	1
20 x 150	S104 20	10	S104 20 K	1
21 x 150	S104 21	10	S104 21 K	1



S107
TÊTE TYPE «PANGAUD»

DIM.	RÉF.		RÉF.	
18 x 150	S107 18	10	S107 18 K	1
1/2	S107 12	10	S107 12 K	1



S108
TÊTE TYPE «GROHE»

DIM.	RÉF.		RÉF.	
3/8	S108 38	10	S108 38 K	1
1/2	S108 12	10	S108 12 K	1
3/4	S108 34	10	S108 34 K	1

Sachet cavalier Sachet plastique

SANITAIRE

TÊTES DE ROBINET



S110
TÊTE TYPE «PORCHER» CHROMÉE
N°511 O96

DIM.	RÉF.		RÉF.	
18 x 150	S110	10	S110 K	1



S111
TÊTE TYPE «PORCHER» CHROMÉE
N°841 O90

DIM.	RÉF.		RÉF.	
18 x 150	S111	10	S111 K	1



S113
TÊTE À PLAQUETTE CÉRAMIQUE

PROFONDEUR DU SIÈGE : 22MM					
DIM.	ROTATION	RÉF.		RÉF.	
1/2	1/4 tour	S113 14	10	S113 14 K	1
1/2	1/2 tour	S113 12	10	S113 12 K	1
1/2	3/4 tour	S113 34	10	S113 34 K	1



S114
TÊTE TYPE «REIMS»

DIM.	RÉF.		RÉF.	
21 x 150	S114	10	S114 K	1



S115
TÊTE TYPE «REIMS»

DIM.	RÉF.		RÉF.	
3/8	S115	10	S115 K	1



S116
TÊTE TYPE «CHAMPAGNE»

DIM.	RÉF.		RÉF.	
21 x 150	S116	10	S116 K	1



S117
TÊTE TYPE «CHAMPAGNE»

DIM.	RÉF.		RÉF.	
1/2	S117	10	S117 K	1



S118
TÊTE «BLOC JET»

DIM.	RÉF.		RÉF.	
1/2	S118	10	S118 K	1



S119
TÊTE «PORCHER»
N°546 O96

DIM.	RÉF.		RÉF.	
18 x 150	S119	10	S119 K	1



S120
TÊTE TYPE «PORCHER CLAPET 13» CHROMÉE
N°820 O96

DIM.	RÉF.		RÉF.	
18 x 150	S120	10	S120 K	1



S121
TÊTE TYPE «PORCHER MONOTROU» CHROMÉE
N°541 O96

DIM.	RÉF.		RÉF.	
18 x 125	S121	10	S121 K	1







S122
TÊTE TYPE «PORCHER 3 TROUS
N° 846 O94

DIM.	RÉF.		RÉF.	
18 x 125	S122	10	S122 K	1



SANITAIRE

BECS UNIVERSELS







DIM.	1/2 BRISE JET	1/2 AÉRATEUR		1/2 BRISE JET	1/2 AÉRATEUR	
	RÉF.	RÉF.		RÉF.	RÉF.	
L 130	S 1	S 8	1	S 1 K	S 8 K	1
L 150	S 2	S 9	1	S 2 K	S 9 K	1
L 200	S 3	S 10	1	S 3 K	S 10 K	1
L 250	S 4	S 11	1	S 4 K	S 11 K	1
L 300	S 5	S 12	1	S 5 K	S 12 K	1
L 350	S 6	S 13	1	S 6 K	S 13 K	1
L 400	S 7	S 14	1	S 7 K	S 14 K	1
DIM.	3/4 BRISE JET	3/4 AÉRATEUR		3/4 BRISE JET	3/4 AÉRATEUR	
	RÉF.	RÉF.		RÉF.	RÉF.	
L 150	S 16	S 23	1	S 16 K	S 23 K	1
L 200	S 17	S 24	1	S 17 K	S 24 K	1
L 250	S 18	S 25	1	S 18 K	S 25 K	1
L 300	S 19	S 26	1	S 19 K	S 26 K	1
L 350	S 20	S 27	1	S 20 K	S 27 K	1
L 400	S 21	S 28	1	S 21 K	S 28 K	1



DIM.	1/2 BRISE JET	1/2 AÉRATEUR		1/2 BRISE JET	1/2 AÉRATEUR	
	RÉF.	RÉF.		RÉF.	RÉF.	
L 150	P 2	P 9	1	P 2 K	P 9 K	1
L 200	P 3	P 10	1	P 3 K	P 10 K	1
L 250	P 4	P 11	1	P 4 K	P 11 K	1
L 300	P 5	P 12	1	P 5 K	P 12 K	1
L 350	P 6	P 13	1	P 6 K	P 13 K	1
L 400	P 7	P 14	1	P 7 K	P 14 K	1
DIM.	3/4 BRISE JET	3/4 AÉRATEUR		3/4 BRISE JET	3/4 AÉRATEUR	
	RÉF.	RÉF.		RÉF.	RÉF.	
L 150	P 16	P 23	1	P 16 K	P 23 K	1
L 200	P 17	P 24	1	P 17 K	P 24 K	1
L 250	P 18	P 25	1	P 18 K	P 25 K	1
L 300	P 19	P 26	1	P 19 K	P 26 K	1
L 350	P 20	P 27	1	P 20 K	P 27 K	1
L 400	P 21	P 28	1	P 21 K	P 28 K	1



DIM.	1/2" - BRISE JET	1/2" - AÉRATEUR		1/2" - BRISE JET	1/2" - AÉRATEUR	
	RÉF.	RÉF.		RÉF.	RÉF.	
L 150 - H 130	C 1	C 3	1	C 1 K	C 3 K	1
L 200 - H 160	C 2	C 4	1	C 2 K	C 4 K	1
L 250 - H 200	-	C 5	1	-	C 5 K	1
DIM.	3/4" - BRISE JET	3/4" - AÉRATEUR		3/4" - BRISE JET	3/4" - AÉRATEUR	
	RÉF.	RÉF.		RÉF.	RÉF.	
L 150 - H 130	C 6	C 8	1	C 6 K	C 8 K	1
L 200 - H 160	C 7	C 9	1	C 7 K	C 9 K	1
L 250 - H 200	-	C 10	1	-	C 10 K	1

Sachet cavalier  Sachet plastique 

SANITAIRE

RÉDUCTIONS CHROMÉES POUR BECS UNIVERSELS



700
ADAPTATEUR MÂLE - MÂLE

ADAPTABLE SUR ROBINETTERIE À SORTIE FEMELLE :	M - M	RÉF.		RÉF.	
Chaffoteau et Maury	1/2 - 15 x 75	700-1	10	700-1 K	1
Jacob Delafon : "série REIMS"	1/2 - 18 x 100	700-2	10	700-2 K	1
Holleville Duverger 1202 - 1402	1/2 - 18 x 150	700-3	10	700-3 K	1
P.A.M. "Confort" 5501 - 5502 - 5503	1/2 - 19 x 100	700-4	10	700-4 K	1
P.A.M. "Dauphine" 3201 - 3202 - 3203	1/2 - 20 x 100	700-5	10	700-5 K	1
Delabie 665	1/2 - 20 x 125	700-6	10	700-6 K	1
P.A.M. 5201 - 5202 - 5203 - Bricard	1/2 - 21 x 100	700-7	10	700-7 K	1
Delabie 645	1/2 - 21 x 150	700-8	10	700-8 K	1
Bricard - Grohe - Porcher	1/2 - 22 x 100	700-9	10	700-9 K	1
T.H.G.	1/2 - 22 x 125	700-10	10	700-10 K	1
Mamoli	1/2 - 23 x 100	700-11	10	700-11 K	1
Idéal Standard : Europa Diff. - Queroy "Regina"	1/2 - 23 x 150	700-12	10	700-12 K	1
Holleville Duverger 1000 - 2000 - Bricard	1/2 - 24 x 100	700-13	10	700-13 K	1



800
ADAPTATEUR MÂLE - FEMELLE

ADAPTABLE SUR ROBINETTERIE À SORTIE MÂLE :	M - F	RÉF.		RÉF.	
E.L.M.	1/2 - 22 x 125	800-1	10	800-1 K	1
Jacob Delafon	1/2 - 18 x 100	800-2	10	800-2 K	1
Jacob Delafon 72 - 76	1/2 - 22 x 150	800-3	10	800-3 K	1
Jacob Delafon 72 - 73	1/2 - 1/2	800-4	10	800-4 K	1
Bricard - Mamoli	1/2 - 5/8	800-5	10	800-5 K	1

LIMITEURS DE DÉBITS ET AÉRATEURS - RECHARGES



N28
AÉRATEUR FEMELLE
AVEC OU SANS LIMITEUR DE DÉBIT

LITRES	DIM.	RÉF.		RÉF.	
6 L	22/100	N28 226	10	N28 226 K	1
8 L		N28 228	10	N28 228 K	1
sans limiteur de débit		N28 22	10	N28 22 K	1



N28
AÉRATEUR MÂLE
AVEC OU SANS LIMITEUR DE DÉBIT

LITRES	DIM.	RÉF.		RÉF.	
6 L	24/100	N28 246	10	N28 246 K	1
8 L		N28 248	10	N28 248 K	1
sans limiteur de débit		N28 28	10	N28 28 K	1
	24/100	N28 24	10	N28 24 K	1



N29
LIMITEUR DE DÉBIT MÂLE - FEMELLE

LITRES	DIM.	RÉF.		RÉF.	
10 L	1/2	N29 10	10	N29 10 K	1
12 L		N29 12	10	N29 12 K	1



RN6
RECHARGES POUR LIMITEUR DE DÉBIT
ET AÉRATEUR

6 LITRES - F 22 X 100 ET M 24 X 100					
RÉF.		RÉF.		RÉF.	
RN6	10	RN6 K			1



RN9
RECHARGES POUR LIMITEUR DE DÉBIT
ET AÉRATEUR

F 22 X 100 ET M 24 X 100					
RÉF.		RÉF.		RÉF.	
RN9	10	RN9 K			1





RN8
RECHARGES POUR LIMITEUR DE DÉBIT
ET AÉRATEUR

8 LITRES - F 22 X 100 ET M 24 X 100					
RÉF.		RÉF.		RÉF.	
RN8	10	RN8 K			1

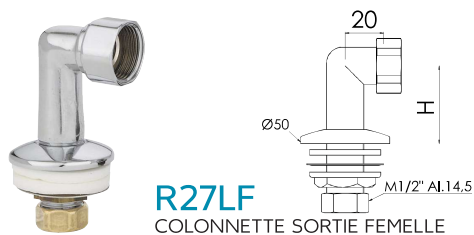

SANITAIRE

RACCORDS SUR GORGE - HAUTEUR 45MM AVEC ROSACE



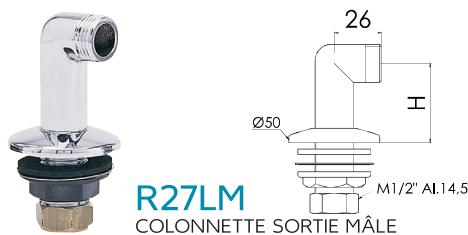

DIM.	H	RÉF.		RÉF.	
1/2	F 1/2	R27LF 12	2	R27LF 12 K	2
	F 3/4	R27LF 34	2	R27LF 34 K	2



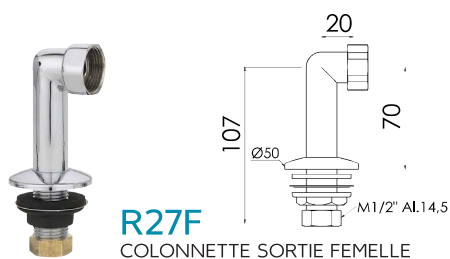

DIM.	H	RÉF.		RÉF.	
1/2	M 1/2	R27LM 12	2	R27LM 12 K	2
	M 3/4	R27LM 34	2	R27LM 34 K	2

RACCORDS SUR GORGE - HAUTEUR 70MM AVEC ROSACE



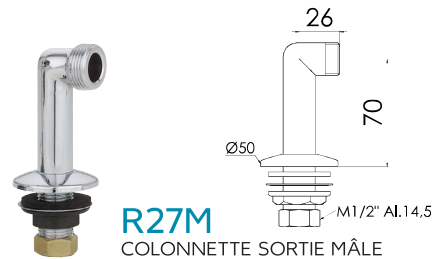

DIM.	L	RÉF.		RÉF.	
1/2	F 1/2	R27F 1212	2	R27F 1212 K	2
	F 3/4	R27F 1234	2	R27F 1234 K	2



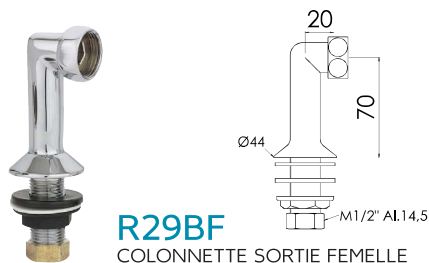

DIM.	L	RÉF.		RÉF.	
1/2	M 1/2	R27M 1212	2	R27M 1212 K	2
	M 3/4	R27M 1234	2	R27M 1234 K	2

RACCORDS SUR GORGE - HAUTEUR 70MM AVEC EMBASE FONDUE

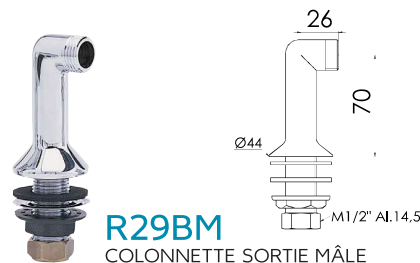

DIM.	L	RÉF.		RÉF.	
1/2	F 1/2	R29BF 12	2	R29BF 12 K	2
	F 3/4	R29BF 34	2	R29BF 34 K	2





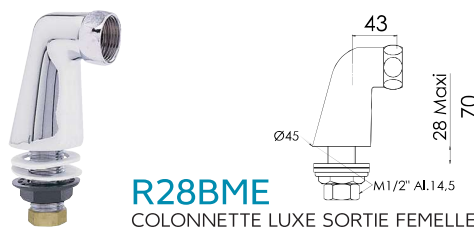

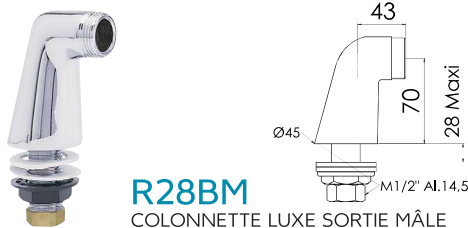

DIM.	L	RÉF.		RÉF.	
1/2	M 1/2	R29BM 12	2	R29BM 12 K	2
	M 3/4	R29BM 34	2	R29BM 34 K	2



DIM.	RÉF.		RÉF.	
1/2	F 3/4	R28BME 12	2	R28BME 12 K



AVEC ÉCROU CB					
DIM.	RÉF.		RÉF.		
1/2	M 3/4	R28BM 12	2	R28BM 12 K	2
SANS ÉCROU CB					
DIM.	RÉF.		RÉF.		
1/2	M 3/4	R28BMS 12	2	R28BMS 12 K	2

Sachet cavalier  Sachet plastique 

SANITAIRE

RACCORDS SUR GORGE

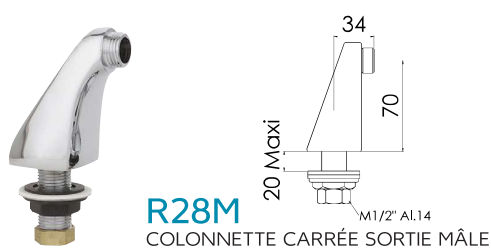
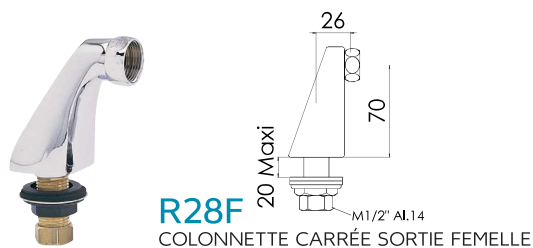

DIM.	H	RÉF.		RÉF.		
1/2	F 1/2	70	R28F 1212	2	R28F 1212 K	2
	F 3/4	70	R28F 1234	2	R28F 1234 K	2

DIM.	H	RÉF.		RÉF.		
1/2	M 1/2	70	R28M 1212	2	R28M 1212 K	2
	M 3/4	70	R28M 1234	2	R28M 1234 K	2

SUR DEMANDE



EXCENTRATION : 22MM

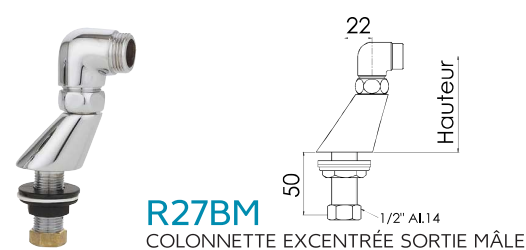
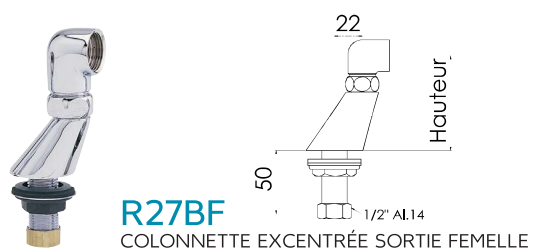

DIM.	H	RÉF.		RÉF.		
1/2	F 1/2	75	R27BF 1212	2	R27BF 1212 K	2
	F 3/4	79	R27BF 1234	2	R27BF 1234 K	2

DIM.	H	RÉF.		RÉF.		
1/2	M 1/2	75	R27BM 1212	2	R27BM 1212 K	2
	M 3/4	79	R27BM 1234	2	R27BM 1234 K	2

EXCENTRATION : 50MM

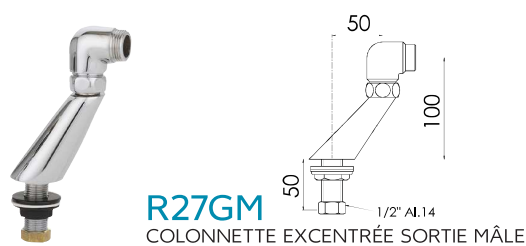
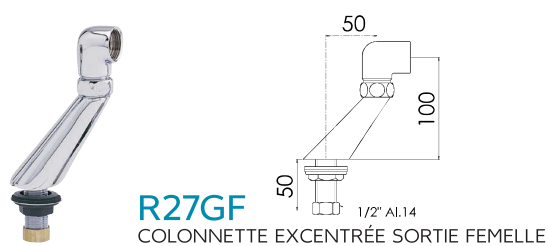

DIM.	H	RÉF.		RÉF.		
1/2	F 3/4	100	R27GF 1234	2	R27GF 1234 K	2

DIM.	H	RÉF.		RÉF.		
1/2	M 3/4	100	R27GM 1234	2	R27GM 1234 K	2

SANITAIRE

RACCORDS EXCENTRÉS



R24CN
RACCORD PLAT
LONG MÂLE - MÂLE

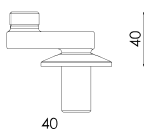

R24CE
RACCORD PLAT
LONG MÂLE - FEMELLE

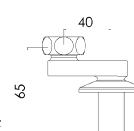

EXCENTRATION : 40 MM

DIM.	H	RÉF.		RÉF.	
1/2	M 1/2	R24CN 1212	2	R24CN 1212 K	2
	M 3/4	R24CN 3412	2	R24CN 3412 K	2

DIM.	H	RÉF.		RÉF.	
1/2	F 1/2	R24CE 1212	2	R24CE 1212 K	2
	F 3/4	R24CE 3412	2	R24CE 3412 K	2



R24BM
RACCORD PLAT
MÂLE - MÂLE

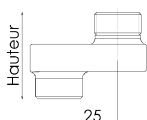

R24B
RACCORD PLAT
MÂLE - FEMELLE

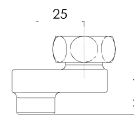

EXCENTRATION : 25 MM

DIM.	H	RÉF.		RÉF.	
1/2	M 1/2	R24BM 1212	2	R24BM 1212 K	2
	M 3/4	R24BM 3412	2	R24BM 3412 K	2

DIM.	H	RÉF.		RÉF.	
M 1/2	F 1/2	R24B 1212	2	R24B 1212 K	2
	F 3/4	R24B 3412	2	R24B 3412 K	2



R25M
RACCORD DROIT
ENVELOPPANT MÂLE - MÂLE

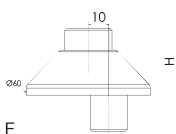

R25
RACCORD DROIT
ENVELOPPANT MÂLE - FEMELLE

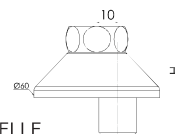

EXCENTRATION : 10MM

DIM.	H	RÉF.		RÉF.	
M 1/2 - M 1/2	34	R25M 1212	2	R25M 1212 K	2
M 1/2 - M 3/4	32	R25M 1234	2	R25M 1234 K	2

DIM.	H	RÉF.		RÉF.	
M 1/2 - F 1/2	36	R25 1212	2	R25 1212 K	2
M 1/2 - F 3/4	34	R25 1234	2	R25 1234 K	2



R26B
RACCORD DROIT
MÂLE - MÂLE

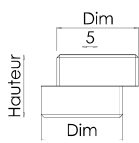

R26
RACCORD DROIT
MÂLE - FEMELLE

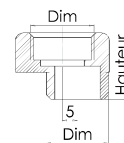

EXCENTRATION : 5MM

DIM.	H	RÉF.		RÉF.	
1/2 - 1/2	20	R26B 1212	2	R26B 1212 K	2
1/2 - 3/4	21	R26B 1234	2	R26B 1234 K	2
3/4 - 3/4	21	R26B 3434	2	R26B 3434 K	2

DIM.	H	RÉF.		RÉF.	
M 1/2 - F 1/2	22	R26 1212	2	R26 1212 K	2
M 1/2 - F 3/4	22	R26 1234	2	R26 1234 K	2
M 3/4 - F 3/4	24	R26 3434	2	R26 3434 K	2



R22BM
RACCORD CONTRE COUDÉ
MÂLE - MÂLE

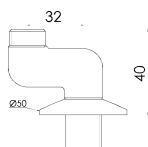

R22B
RACCORD CONTRE COUDÉ
MÂLE - FEMELLE

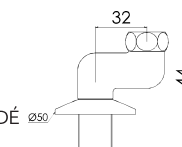

EXCENTRATION : 32MM

DIM.	H	RÉF.		RÉF.	
3/8	M 1/2	R22BM 3812	2	R22BM 3812 K	2
	M 1/2	R22BM 1212	2	R22BM 1212 K	2
1/2	M 3/4	R22BM 1234	2	R22BM 1234 K	2

DIM.	H	RÉF.		RÉF.	
3/8	F 1/2	R22B 3812	2	R22B 3812 K	2
	F 1/2	R22B 1212	2	R22B 1212 K	2
1/2	F 3/4	R22B 1234	2	R22B 1234 K	2



R22
RACCORD CONTRE COUDÉ
MÂLE - FEMELLE

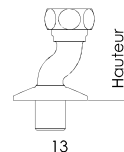

EXCENTRATION : 13MM

DIM.	H	RÉF.		RÉF.	
3/8	F 1/2	R22 3812	2	R22 3812 K	2
	F 1/2	R22 1212	2	R22 1212 K	2
1/2	F 3/4	R22 1234	2	R22 1234 K	2

Sachet cavalier Sachet plastique

SANITAIRE

RACCORDS DROITS



R20
RACCORD DROIT FEMELLE

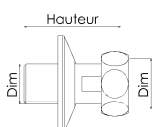

DIM.	HT.	RÉF.		RÉF.		
M 3/8	F 1/2	35	R20 3812	2	R20 3812 K	2
	F 1/2	45	R20 L3812	2	R20 L3812 K	2
	F 1/2	65	R20 T3812	2	R20 T3812 K	2
M 1/2	F 1/2	40	R20 12	2	R20 12 K	2
	F 1/2	60	R20 L1212	2	R20 L1212 K	2
	F 3/4	45	R20 1234	2	R20 1234 K	2



R20B
RACCORD DROIT MÂLE

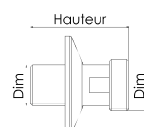

DIM.	HT.	RÉF.		RÉF.		
M 3/8	M 1/2	52	R20B 3812	2	R20B 3812 K	2
M 1/2	M 1/2	43	R20B 1212	2	R20B 1212 K	2
	M 3/4	46	R20B 1234	2	R20B 1234 K	2



R18
TRAVERSÉE DE CLOISON
FEMELLE / ROSACE Ø 60

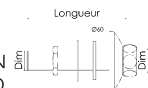

DIM. - LONGUEUR	RÉF.		RÉF.	
M 1/2 - F 1/2 - L.115 mm	R18 12	1	R18 12 K	1



R19
TRAVERSÉE DE CLOISON
MÂLE / ROSACE Ø 60

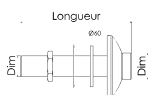

DIM. - LONGUEUR	RÉF.		RÉF.		
M 1/2	M 1/2 - L.70 mm	R19 C1212	1	R19 C1212 K	1
	M 1/2 - L.110 mm	R19 1212	1	R19 1212 K	1
	M 3/4 - L.113 mm	R19 1234	1	R19 1234 K	1



R23
RACCORD COURT
FEMELLE - FEMELLE

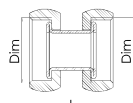

DIM.	L	RÉF.		RÉF.		
F 3/8	F 1/2	18	R23 3812	2	R23 3812 K	2
	F 1/2		R23 1212	2	R23 1212 K	2
F 1/2	F 3/4	20	R23 1234	2	R23 1234 K	2
F 3/4	F 3/4		R23 3434	2	R23 3434 K	2

Autres dimensions sur demande



R95
RACCORD LONG
FEMELLE - FEMELLE

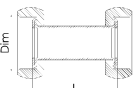

DIM.	L	RÉF.		RÉF.		
F 3/8	F 1/2	42	R95 3812	2	R95 3812 K	2
	F 1/2	39	R95 1212	2	R95 1212 K	2
F 1/2	F 3/4	41	R95 1234	2	R95 1234 K	2
	F 3/4	40	R95 3434	2	R95 3434 K	2



D25PC
ALLONGE BROCHÉE 6 PANS
INTÉRIEUR «4461»

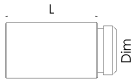

DIM.	L	RÉF.		RÉF.	
3/8	25	D25PC 3825	2	D25PC 3825 K	2
	50	D25PC 3850	2	D25PC 3850 K	2
	75	D25PC 3875	2	D25PC 3875 K	2
	100	D25PC 38100	2	D25PC 38100 K	2
1/2	25	D25PC 1225	2	D25PC 1225 K	2
	50	D25PC 1250	2	D25PC 1250 K	2
	75	D25PC 1275	2	D25PC 1275 K	2
	100	D25PC 12100	2	D25PC 12100 K	2
3/4	25	D25PC 3425	2	D25PC 3425 K	2
	50	D25PC 3450	2	D25PC 3450 K	2
	75	D25PC 3475	2	D25PC 3475 K	2
	100	D25PC 34100	2	D25PC 34100 K	2



R16
TRAVERSÉE DE CLOISON
FEMELLE / ROSACE Ø 50

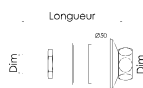

DIM. - LONGUEUR	RÉF.		RÉF.		
M 1/2	F 1/2 - L.75 mm	R16 12A	1	R16 12A K	1
	F 1/2 - L.115 mm	R16 12B	1	R16 12B K	1



R17
TRAVERSÉE DE CLOISON
MÂLE / ROSACE Ø 50

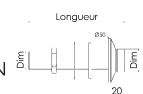

DIM. - LONGUEUR	RÉF.		RÉF.		
M 1/2	M 1/2 - L.70 mm	R17 12A	1	R17 12A K	1
	M 3/4 - L.73 mm	R17 12B	1	R17 12B K	1
	M 1/2 - L.110 mm	R17 12C	1	R17 12C K	1
	M 3/4 - L.113 mm	R17 12D	1	R17 12D K	1
	M 3/4 - L.133 mm	R17 12E	1	R17 12E K	1



R94
RACCORD MÂLE - FEMELLE
ÉCROU TOURNANT

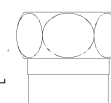

DIM.	L	RÉF.		RÉF.		
M 1/2	F 1/2	17	R94 1212	2	R94 1212 K	2
	F 3/4	17	R94 1234	2	R94 1234 K	2



R97
RACCORD
MÂLE - MÂLE BROCHÉ

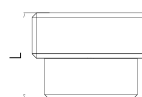

DIM.	L	RÉF.		RÉF.		
M 1/2	M 1/2	20	R97 1212	2	R97 1212 K	2
	M 3/4	19	R97 1234	2	R97 1234 K	2
	M 3/4	22	R97 3434	2	R97 3434 K	2



R99
RACCORD MÂLE - FEMELLE

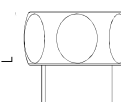

DIM.	L	RÉF.		RÉF.		
M 3/8	F 1/2	22,5	R99 3812	2	R99 3812 K	2
M 1/2	F 3/4	23	R99 1234	2	R99 1234 K	2

SANITAIRE

RACCORDS D'ÉQUERRE



R27BC
RACCORD D'ÉQUERRE
MÂLE - MÂLE

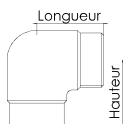

DIM.	L	H	RÉF.		RÉF.	
1/2 - 1/2	26	26	R27BC 12	2	R27BC 12 K	2
3/4 - 3/4	33	33	R27BC 34	2	R27BC 34 K	2



R27BB
RACCORD D'ÉQUERRE
MÂLE - FEMELLE

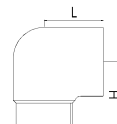

DIM.	L	H	RÉF.		RÉF.		
M 1/2	F 3/8	20	27	R27BB 1238	2	R27BB 1238 K	2
	F 1/2	17	26	R27BB 1212	2	R27BB 1212 K	2
M 3/4	F 3/4	20	35	R27BB 3434	2	R27BB 3434 K	2



R27BA
RACCORD D'ÉQUERRE
MÂLE - FEMELLE

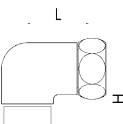

ÉCROU TOURNANT							
DIM.	L	H	RÉF.		RÉF.		
M 1/2	F 1/2	27	25	R27BA 1212	2	R27BA 1212 K	2
	F 3/4	22	25	R27BA 1234	2	R27BA 1234 K	2



R27BE
RACCORD D'ÉQUERRE
FEMELLE - FEMELLE

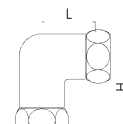

ÉCROUS TOURNANTS						
DIM.	L	H	RÉF.		RÉF.	
1/2 - 1/2	30	30	R27BE 1212	2	R27BE 1212 K	2
1/2 - 3/4	30	30	R27BE 1234	2	R27BE 1234 K	2



R21
RACCORD COUDE FILETÉ
MÂLE - FEMELLE

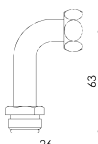

DIM.	H	RÉF.		RÉF.	
M 1/2 - F 1/2	63	R21	2	R21 K	2



R98
RACCORD COUDE FILETÉ
MÂLE - FEMELLE AVEC ROSACE

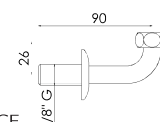

DIM.	RÉF.		RÉF.	
M 1/2 - F 3/8	R98 1238	2	R98 1238 K	2

APPLIQUES



R40B
APPLIQUE MÂLE - FEMELLE
Ø 52 AVEC ÉCROU

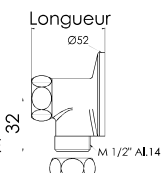

DIM.	L	RÉF.		RÉF.		
M 1/2	F 1/2	46	R40B 12	2	R40B 12 K	1
	F 3/4	44	R40B 34	2	R40B 34 K	1



R41B
APPLIQUE MÂLE - FEMELLE
Ø 52 SANS ÉCROU

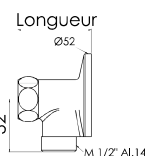

DIM.	L	RÉF.		RÉF.		
M 1/2	F 1/2	46	R41B 12	2	R41B 12 K	1
	F 3/4	44	R41B 34	2	R41B 34 K	1



R40
APPLIQUE MÂLE - MÂLE
Ø 52 AVEC ÉCROU

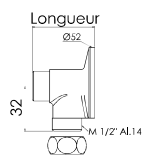

DIM.	L	RÉF.		RÉF.		
M 1/2	M 1/2	44	R40 12	2	R40 12 K	1
	M 3/4	42	R40 34	2	R40 34 K	1



R41
APPLIQUE MÂLE - MÂLE
Ø 52 SANS ÉCROU

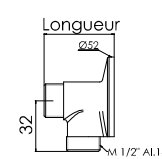

DIM.	L	RÉF.		RÉF.		
M 1/2	M 1/2	44	R41 12	2	R41 12 K	1
	M 3/4	42	R41 34	2	R41 34 K	1

Sachet cavalier

Sachet plastique

SANITAIRE

ROSACES - ÉCROU - CACHE-TRous



A89C - A91C
ROSACE CONIQUE Ø 60

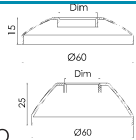

CHROMÉE					
DIM.	RÉF.		RÉF.		
3/8	A89C 38	10	A89C 38 K		2
1/2	A89C 12	10	A89C 12 K		2
3/4	A89C 34	10	A89C 34 K		2
1/2	A91C 12	10	A91C 12 K		2

A89C : conique hauteur 15 mm
A91C : conique hauteur 25 mm



A73CA
ROSACE À CLIPSER

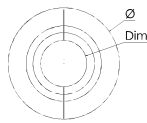

CHROMÉE					
DIM.	Ø	RÉF.		RÉF.	
10	54	A73CA 10	10	A73CA 10 K	2
12	54	A73CA 12	10	A73CA 12 K	2
14	54	A73CA 14	10	A73CA 14 K	2
16	54	A73CA 16	10	A73CA 16 K	2
18 - 3/8	54	A73CA 18	10	A73CA 18 K	2
21 - 1/2	54	A73CA 21	10	A73CA 21 K	2
26 - 3/4	65	A73CA 26	10	A73CA 26 K	2
33 - 1"	65	A73CA 33	10	A73CA 33 K	2



A73
ROSACE À MOULURE

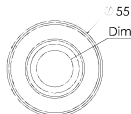

CHROMÉE					
DIM.	RÉF.		RÉF.		
3/8	A73C 38	10	A73C 38 K		2
1/2	A73C 12	10	A73C 12 K		2
3/4	A73C 34	10	A73C 34 K		2

BRUTE					
DIM.	RÉF.		RÉF.		
3/8	A73 38	10	A73 38 K		2
1/2	A73 12	10	A73 12 K		2
3/4	A73 34	10	A73 34 K		2



R31B
CACHE-TRous LUXE

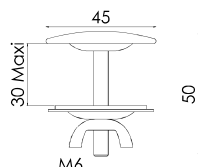

RÉF.		RÉF.	
R31B	10	R31B K	2



D1OSC
ÉCROU SANITAIRE POLI-CHROMÉ

DIM.	Ø	RÉF.		RÉF.	
3/8	8	D1OSC 388	10	D1OSC 388 K	2
	10	D1OSC 3810	10	D1OSC 3810 K	2
	11	D1OSC 3811	10	D1OSC 3811 K	2
	12	D1OSC 3812	10	D1OSC 3812 K	2
	12,5	D1OSC 3812.5	10	D1OSC 3812.5 K	2
	13	D1OSC 3813	10	D1OSC 3813 K	2
1/2	10	D1OSC 1210	10	D1OSC 1210 K	2
	12	D1OSC 1212	10	D1OSC 1212 K	2
	14	D1OSC 1214	10	D1OSC 1214 K	2
	15	D1OSC 1215	10	D1OSC 1215 K	2
	16	D1OSC 1216	10	D1OSC 1216 K	2
	17	D1OSC 1217	10	D1OSC 1217 K	2
3/4	16	D1OSC 3416	10	D1OSC 3416 K	2
	19	D1OSC 3419	10	D1OSC 3419 K	2
	21	D1OSC 3421	10	D1OSC 3421 K	2
1"	26	D1OSC 126	5	D1OSC 126 K	2
1"1/4	33	D1OSC 11433	5	D1OSC 11433 K	2
1"1/2	39	D1OSC 11239	5	D1OSC 11239 K	2
	40	D1OSC 11240	5	D1OSC 11240 K	2



A94C
ROSACE BOMBÉE

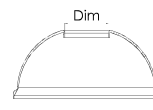

CHROMÉE					
DIM.	RÉF.		RÉF.		
10	A94C 10	10	A94C 10 K		2
12	A94C 12	10	A94C 12 K		2
14	A94C 14	10	A94C 14 K		2
16	A94C 16	10	A94C 16 K		2
32	A94C 32	10	A94C 32 K		2
40	A94C 40	10	A94C 40 K		2



A90C
ROSACE SIMPLE
BOMBÉE À VISSER

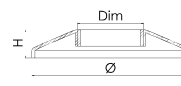

CHROMÉE						
DIM.	Ø	H	RÉF.		RÉF.	
3/8	40	7	A90C 38	10	A90C 38 K	2
1/2	49	9	A90C 12	10	A90C 12 K	2
3/4	51	13	A90C 34	10	A90C 34 K	2



R31
CACHE-TRous ORDINAIRE

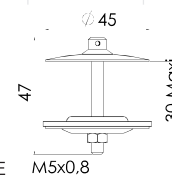

RÉF.		RÉF.	
R31	10	R31 K	2

SANITAIRE

ROBINETS D'ARRÊT SOUS LAVABO



RAL
ROBINET D'ARRÊT 1/4 TOUR - LONG

DIM.	RÉF.		RÉF.	
3/8 - 10	RAL 3810	5	RAL 3810 K	1
1/2 - 10	RAL 1210	5	RAL 1210 K	1



RAC
ROBINET D'ARRÊT 1/4 TOUR - COURT

DIM.	RÉF.		RÉF.	
1/2 - 10	RAC 1210	5	RAC 1210 K	1



RACF
ROBINET D'ARRÊT
MÂLE - FEMELLE 3/8

FILTRE INCORPORÉ - ÉCROU LIBRE				
DIM.	RÉF.		RÉF.	
3/8	RACF	5	RACF K	1



FIL
FILTRE MÂLE - FEMELLE

ÉCROU LIBRE				
DIM.	RÉF.		RÉF.	
M 3/8 - F 3/8	FIL 38	5	FIL 38 K	1
M 1/2 - F 1/2	FIL 12	5	FIL 12 K	1



D26BS
ROBINET D'ARRÊT BICÔNE

À MANETTE				
DIM.	RÉF.		RÉF.	
10	12	D26BS 1012	5	D26BS 1012 K
	14	D26BS 1014	5	D26BS 1014 K



D26VS
ROBINET D'ARRÊT BICÔNE

À VIS				
DIM.	RÉF.		RÉF.	
10	12	D26VS 1012	5	D26VS 1012 K
	14	D26VS 1014	5	D26VS 1014 K



D27BS
ROBINET D'ARRÊT MÂLE - MÂLE

À MANETTE				
DIM.	RÉF.		RÉF.	
M 3/8 - M 3/8	D27BS 38	5	D27BS 38 K	1
M 1/2 - M 1/2	D27BS 12	5	D27BS 12 K	1



D27VS
ROBINET D'ARRÊT MÂLE - MÂLE

À VIS				
DIM.	RÉF.		RÉF.	
M 3/8 - M 3/8	D27VS 38	5	D27VS 38 K	1
M 1/2 - M 1/2	D27VS 12	5	D27VS 12 K	1



D28BS
ROBINET D'ARRÊT MÂLE - FEMELLE

À MANETTE - ÉCROU LIBRE				
DIM.	RÉF.		RÉF.	
M 3/8 - F 3/8	D28BS 38	5	D28BS 38 K	1



D28VS
ROBINET D'ARRÊT MÂLE - FEMELLE

À VIS - ÉCROU LIBRE				
DIM.	RÉF.		RÉF.	
M 3/8 - F 3/8	D28VS 38	5	D28VS 38 K	1
M 1/2 - F 1/2	D28VS 12	5	D28VS 12 K	1



D29BS
ROBINET D'ARRÊT BICÔNE - FEMELLE

À MANETTE - ÉCROU LIBRE				
DIM.	RÉF.		RÉF.	
3/8 - 10	D29BS 3810	5	D29BS 3810 K	1
3/8 - 12	D29BS 3812	5	D29BS 3812 K	1



D29VS
ROBINET D'ARRÊT BICÔNE - FEMELLE

À VIS - ÉCROU LIBRE				
DIM.	RÉF.		RÉF.	
1/2 - 12	D29VS 1212	5	D29VS 1212 K	1

Sachet cavalier Sachet plastique

SANITAIRE

ROBINETS DE CHASSE



D26

ÉQUERRE À PRESSE ÉTOUPE

DIM.	RÉF. BRUT	RÉF. CHROMÉ		RÉF. BRUT	RÉF. CHROMÉ	
3/8	D26 38	D26C 38	10	D26 38 K	D26C 38 K	1
1/2	D26 12	D26C 12	10	D26 12 K	D26C 12 K	1



D26E

ÉQUERRE À JOINT TORIQUE - CHANTIER

DIM.	RÉF. BRUT	RÉF. CHROMÉ		RÉF. BRUT	RÉF. CHROMÉ	
3/8	D26E 38	D26CE 38	10	D26E 38 K	D26CE 38 K	1



D26B

DROIT À PRESSE ÉTOUPE

DIM.	RÉF. BRUT	RÉF. CHROMÉ		RÉF. BRUT	RÉF. CHROMÉ	
3/8	D26B 38	D26BC 38	10	D26B 38 K	D26BC 38 K	1
1/2	D26B 12	D26BC 12	10	D26B 12 K	D26BC 12 K	1



D26P

DROIT À JOINT TORIQUE - CHANTIER

DIM.	RÉF. BRUT	RÉF. CHROMÉ		RÉF. BRUT	RÉF. CHROMÉ	
3/8	D26P 38	D26PC 38	10	D26P 38 K	D26PC 38 K	1



D26SC

ÉQUERRE À BOISSEAU SPHÉRIQUE
1/4 TOUR

DIM.	RÉF. BRUT		RÉF. BRUT	
3/8	D26SC 38	10	D26SC 38 K	1
	D26SC 38NF	10	D26SC 38NF K	1



D26DC

DROIT À BOISSEAU SPHÉRIQUE
1/4 TOUR

DIM.	RÉF. BRUT		RÉF. BRUT	
3/8	D26DC 38	10	D26DC 38 K	1
	D26DC 38NF	10	D26DC 38NF K	1

D50

ROBINET DE RINÇAGE ARRIVÉE 3/4 - SORTIE Ø 26 MM

DIM.	RÉF. CHROMÉ		RÉF. CHROMÉ	
3/4	D50 34	1	D50 34 K	1

SANITAIRE

ROBINETS FLOTTEUR



D30
AVEC TIGE SANS RACCORD

DIM.	RÉF.	
3/8	D30 38	1
1/2	D30 12	1



D30B
AVEC TIGE AVEC RACCORD

DIM.	RÉF.	
3/8	D30B 38	1
1/2	D30B 12	1



D31
RÉGLABLE SANS RACCORD

DIM.	RÉF.	
3/8	D31 38	1
1/2	D31 12	1



D31B
RÉGLABLE AVEC RACCORD

DIM.	RÉF.	
3/8	D31B 38	1
1/2	D31B 12	1



D29
BOULE FLOTTEUR
CUIVRE

8

RÉF.	
D29	1



D29B
BOULE FLOTTEUR
PLASTIQUE

RÉF.	
D29B	1



D300
TUBE D'ALIMENTATION
DROIT

8

DIM.	RÉF.	
3/8	D300	1



D310
TUBE D'ALIMENTATION
COUDÉ

DIM.	RÉF.	
3/8	D310	1

Sachet plastique

SANITAIRE

MÉCANISMES DE CHASSE

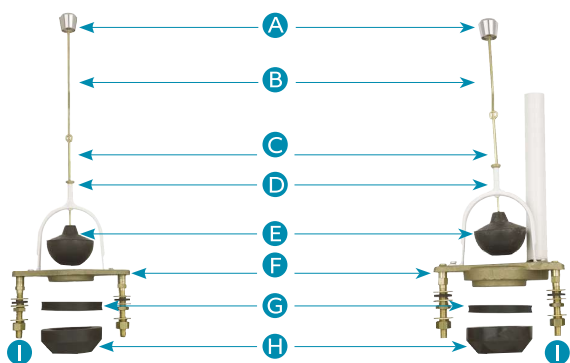

JDA
ADAPTABLE JACOB DELAFON
SANS TROP PLEIN

DÉSIGNATION	RÉF.	
Complet	JDA	1
A : Bouton chromé	MCA	1
B : Tige coudée	MCB	1
C : Tige de cloche	MCC	1
D : Étrier	MCD	1
E : Cloche	MCE	1
F : Siège laiton	MCF	1
G : joint de siège	MCG	1
H : joint conique cuvette	MCH	1
I : Visserie de fixation	MCI	1

JDAS
ADAPTABLE JACOB DELAFON
AVEC TROP PLEIN

DÉSIGNATION	RÉF.	
Complet	JDAS	1
A : Bouton chromé	MCA	1
B : Tige coudée	MCJB	1
C : Tige de cloche	MCC	1
D : Étrier	MCD	1
E : Cloche	MCE	1
F : Siège avec trop plein	MCJF	1
G : joint de siège	MCJG	1
H : joint conique cuvette	MCH	1
I : Visserie de fixation	MCI	1

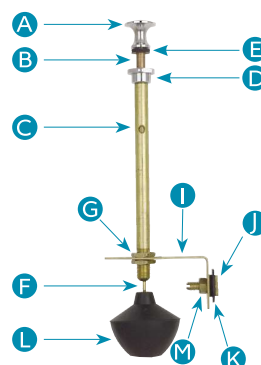

ISA
ADAPTABLE IDÉAL STANDARD

DÉSIGNATION	RÉF.	
Complet	ISA	1
A : Bouton chromé	MCIA	1
B : Tige tube cuivre	MCIB	1
C : Guide	MCIC	1
D : Écrou serrage rapide	MCID	1
E : Joint caoutchouc	MCIE	1
F : Tige de cloche	MCIF	1
G : Contre écrou	MCIG	1
I : Support	MCII	1
J : Vis fendue	MCIJ	1
K : Joint moulé	MCIK	1
L : Cloche	MCIL	1
M : Écrou	MCIM	1

MÉCANISME POUR BIDET PIVOTANT



S12SD
SIPHON DE SOL DROIT
CHROMÉ

DIM.	RÉF.	
100 x 100	S12SD 100	1
140 x 140	S12SD 140	1



S12SC
SIPHON DE SOL COUDÉ
CHROMÉ

DIM.	RÉF.	
100 x 100	S12SC 100	1
140 x 140	S12SC 140	1



MÉCANISME POUR BIDET PIVOTANT

DÉSIGNATION	RÉF.	
Plateau pivotant	ABI	1
Flexible évacuation	BBI	1
Siphon	CBI	1
Flexible alimentation	DBI	1
Robinet monotrou	EBI	1

AVEC MÉLANGEUR		SANS MÉLANGEUR	
RÉF.		RÉF.	
BIAM	1	BISM	1

Ensemble complet comprenant :
 - plateau + pivot
 - vis
 - robinetterie (avec ou sans mélangeur)
 - vidage + siphon
 - flexible alimentation
 - flexible évacuation

SANITAIRE

ACCESSOIRES DE FIXATION



CAT
CONSOLE ACIER

LONGUEUR : 220 MM , LA PAIRE

DIM.	RÉF.	
Brutes + taquets droits	CATD	2
Brutes + taquets pivotants	CATP	2



CAT
CONSOLE ACIER

LONGUEUR : 280 MM , LA PAIRE

DIM.	RÉF.	
Brutes + taquets droits	CATL	2
Brutes + taquets pivotants	CATR	2



CAP
CONSOLE ACIER
+ PORTE SERVIETTE

LONGUEUR : 320 MM , LA PAIRE

DIM.	RÉF.	
Brutes + taquets droits	CAPE	2
Brutes + taquets pivotants	CAPP	2



VIF
VIS DE FIXATION

QUANTITÉ	RÉF.	
Les 2	VIF	2



V5 - V6
VIS + CACHE TÊTE

LES 2

DIM.	RÉF.	
5	50 V5 50	2
	60 V5 60	2
6	50 V6 50	2
	60 V6 60	2



ATT - ALL
ATTACHE LAVABO

ACIER BICHROMATÉ

QUANTITÉ	RÉF.	
Les 2	ATT 2	2
L'unité	ATT U	1

ALUMINIUM

QUANTITÉ	RÉF.	
Les 2	ALL 2	2
L'unité	ALL U	1

MACHINE À LAVER

APPLIQUES



R59
APPLIQUE NUE
BRUTE

DIM.	RÉF.		RÉF.	
3/8	R59 38	5	R59 38 K	1
1/2	R59 12	10	R59 12 K	1
3/4	R59 34	5	R59 34 K	1



R59B
APPLIQUE AVEC ÉCROU
COLLET BATTU BRUTE

DIM.	RÉF.		RÉF.	
3/8 - 12	R59B 38	5	R59B 38 K	1
1/2 - 14	R59B 12	10	R59B 12 K	1
3/4 - 16	R59B 34	5	R59B 34 K	1



R59C
APPLIQUE NUE CHROMÉE

DIM.	RÉF.		RÉF.	
3/8	R59C 38	5	R59C 38 K	1
1/2	R59C 12	10	R59C 12 K	1
3/4	R59C 34	5	R59C 34 K	1



R59BC
APPLIQUE AVEC ÉCROU
COLLET BATTU CHROMÉE

DIM.	RÉF.		RÉF.	
3/8 - 12	R59BC 38	5	R59BC 38 K	1
1/2 - 14	R59BC 12	10	R59BC 12 K	1
3/4 - 16	R59BC 34	5	R59BC 34 K	1



R59S
APPLIQUE AVEC PIQUAGE MÂLE 3/8
ET 6 PANS

	DIM.	RÉF.		RÉF.	
BRUTE	M1/2 - F 1/2 - M 3/8	R59S	5	R59S K	1
CHROMÉE	M1/2 - F 1/2 - M 3/8	R59S C	5	R59S C K	1



R59SNB
APPLIQUE AVEC PIQUAGE MÂLE 3/8

	DIM.	RÉF.		RÉF.	
BRUTE	M1/2 - F 1/2 - M 3/8	R59SNB	5	R59SNB K	1
CHROMÉE	M1/2 - F 1/2 - M 3/8	R59SNB C	5	R59SNB C K	1



ADC
APPLIQUE DOUBLE
CHROMÉE

DIM.	RÉF.		RÉF.	
1/2 - 1/2	ADC 12	1	ADC 12 K	1



C59
APPLIQUE AVEC ÉCROU
TOURNANT 1/2 BRUTE

DIM.	RÉF.		RÉF.	
1/2 - 12	C59 1234	10	C59 1234 K	1

MACHINE À LAVER

ROBINETS



R6BO
ROBINET OBLIQUE

DIM.	RÉF.		RÉF.	
1/2 - 3/4	R6BO 1234	1	R6BO 1234 K	1



RAP
ROBINET APPLIQUE

DIM.	RÉF.		RÉF.	
1/2 - 3/4	RAP	1	RAP K	1



RAPE
ROBINET APPLIQUE AVEC
ÉCROU COLLET BATTU

DIM.	Ø	RÉF.		RÉF.	
1/2	12	RAPE 12	1	RAPE 12 K	1
	14	RAPE 14	1	RAPE 14 K	1



R7
ROBINET ÉQUERRE 1/4 TOUR

DIM.	RÉF.		RÉF.	
1/2	R7 1212	1	R7 1212 K	1
	R7 1234	1	R7 1234 K	1



R39
ROBINET DOUBLE SORTIE
3/4 ET 3/8 - ARRIVÉE 1/2

DIM.	RÉF.		RÉF.	
3/4 - 3/8	R39	1	R39 K	1



R6BP
ROBINET OBLIQUE
POLI-CHROMÉ

CROISILLON MÉTAL				
DIM.	RÉF.		RÉF.	
1/2 - 3/4	R6BP 1	1	R6BP 1 K	1
CROISILLON ABS				
DIM.	RÉF.		RÉF.	
1/2 - 3/4	R6BP 2	1	R6BP 2 K	1



R6BX
ROBINET LUXE

CROISILLON MÉTAL				
DIM.	RÉF.		RÉF.	
1/2 - 3/4	R6BX	1	R6BX K	1



R6B
ROBINET AUTO-FORANT
POUR TUBE Ø 10 À 16

RÉF.		RÉF.	
R6B	1	R6B K	1



RST10
ROBINET SUR TABLE

DIM.	RÉF.		RÉF.	
1/2 - 1/2	RST10	1	RST10 K	1

MACHINE À LAVER

ROBINETS



R10CN
ROBINET DOUBLE VOIE
AVEC AÉRATEUR

DIM.	RÉF.		RÉF.	
1/2 - 3/4	R10CN	1	R10CN K	1



R7D
ROBINET DROIT 1/4 TOUR

DIM.	RÉF.		RÉF.	
1/2 - 3/4	R7D 1234	1	R7D 1234 K	1



R10
ROBINET DOUBLE VOIE
SANS AÉRATEUR

DIM.	RÉF.		RÉF.	
1/2 - 3/4	R10	1	R10 K	1



RD71234
ROBINET DOUBLE POLI-CHROMÉ
(MAL + LAVE VAISSELLE)

DIM.	RÉF.		RÉF.	
1/2 - 3/4	RD71234	1	RD71234 K	1



COML
COLIS POUR MACHINE À LAVER

RÉF.	
COML	1

comprenant :

- 10 robinets MAL 1/2 - 3/4 réf. : R6B01234
- 10 appliques chromées sur brut 1/2 - 1/2 avec écrou CB Ø 12 ou 14 réf. : R59BC12
- 10 siphons simple sortie horizontale Ø 40 réf. : S21PH



R7B
ROBINET DOUBLE CHROMÉ SUR
BRUT (MAL + LAVE VAISSELLE)

DIM.	RÉF.		RÉF.	
1/2 - 3/4	R7B	1	R7B K	1

FILTRES ANTI CALCAIRE



FILTRE À CHAPEAU

Ø	RÉF.	U.C.*		RÉF.	U.C.*	
3/8	O213	1	10	O210	1	25
1/2	O214	1	10	O211	1	25
3/4	O215	1	10	O212	1	25

U.C.* : unité de commande



JOINT FILTRE PLAT

FILTETAGE BECS	RÉF.	U.C.*		RÉF.	U.C.*	
3/8	O216	1	10	O217	1	25
1/2	O218	1	10	O219	1	25
3/4	O220	1	10	O222	1	25
3/4 métal				O221	1	25

U.C.* : unité de commande

MACHINE À LAVER

SIPHONS PLASTIQUE



S21PV
SIPHON Ø 40

SORTIE	RÉF.	V	RÉF.	
Vert.	S21PV	1	S21PV K	1



S21PH
SIPHON Ø 40

SORTIE	RÉF.	V	RÉF.	
Horiz.	S21PH	1	S21PH K	1



S21PHV
SIPHON Ø 40

SORTIE	RÉF.	V	RÉF.	
Vert.	S21PHV	1	S21PHV K	1

SIPHONS PLASTIQUE AVEC ENTONNOIR



S21PVE
SIPHON Ø 40

SORTIE	RÉF.	V	RÉF.	
Vert.	S21PVE	1	S21PVE K	1



S21PHE
SIPHON Ø 40

SORTIE	RÉF.	V	RÉF.	
Horiz.	S21PHE	1	S21PHE K	1

ALIMENTATION & VIDAGE



ENT
ENTONNOIR POUR 2 SIPHONS
DE MACHINE À LAVER

PLASTIQUE				
RÉF.	V	RÉF.		
ENT	1	ENT K	1	



VC
CROSSE + 2 EMBOUTS

POUR TUYAU ANNELÉ				
RÉF.	V	RÉF.		
VC	1	VC K	1	



TC
TUYAU DE VIDAGE + CROSSE

DIM.	RÉF.	V	RÉF.	
1,50 m	TC 150	1	TC 150 K	1
2,00 m	TC 200	1	TC 200 K	1
2,50 m	TC 250	1	TC 250 K	1



JV
JONCTION DROITE

PLASTIQUE POUR RACCORDER 2 TUYAUX DE VIDAGE				
RÉF.	V	RÉF.		
JV	1	JV K	1	



YV34
JONCTION Y FILETÉE AVEC ÉCROU MOBILE

LAITON				
DIM.	RÉF.	V	RÉF.	
entrée 3/4 - sortie 3/4	YV34	1	YV34 K	1



YVP34
JONCTION Y FILETÉE
AVEC ÉCROU MOBILE

PLASTIQUE				
DIM.	RÉF.	V	RÉF.	
entrée 3/4 - sortie 3/4	YVP34	1	YVP34 K	1

MACHINE À LAVER

ALIMENTATION & VIDAGE



TA
TUYAU ENTRÉE ET
SORTIE DROITES 3/4"

DIM.	RÉF.	V	RÉF.	
1,50 m	TA 150	1	TA 150 K	1
2,00 m	TA 200	1	TA 200 K	1
2,50 m	TA 250	1	TA 250 K	1



RTV
RALLONGE DE TUYAU 3/4"

ENTRÉE ET SORTIES DROITES				
1 embout droit mâle 3/4 et 1 embout femelle 3/4				
DIM.	RÉF.	V	RÉF.	
1,50 M	RTV	1	RTV K	1



TAM
TUYAU ENTRÉE DROITE 3/4"
SORTIE COUDÉE 3/4"

DIM.	RÉF.	V	RÉF.	
1,50 m	TAM 150	1	TAM 150 K	1
2,00 m	TAM 200	1	TAM 200 K	1
2,50 m	TAM 250	1	TAM 250 K	1



TUC
TUYAU EN COURONNE
POUR MACHINE À LAVER

DIM.	RÉF.	V
25 m	TUC 25	1



TUV
TUYAU DE VIDAGE EN COURONNE

DIM.	RÉF.	V
25 m	TUV 25	1

Sachet cavalier  Vrac  Sachet plastique 

